

REAPER 7.0: What's New

Summary of major changes and new features

October 2023

This document describes the main changes and new features introduced in REAPER 7.00.

The order in which the topics are presented is of no significance: it certainly does not represent an attempt to rank them in order of importance.

It does not attempt to cover every change and improvement. In particular, it does not include:

- ◆ Bug fixes.
- ◆ Performance improvements.
- ◆ Changes which happen in the background, have no obvious impact on, and require no action from users.
- ◆ Relatively minor changes

See also Page 13 of the REAPER 7.00 User Guide – What's New In This Edition

For a complete and comprehensive list, open REAPER and choose **Help, Changelog** from the menu.

For a better understanding of many of these features you are also recommended to download the full User Guide. Go to <http://reaper.fm/userguide.php>.

REAPER 7.0: What's New

Please read this first!

This guide is *only* concerned with describing the main new features introduced to REAPER in v 7.00

Many of these features will be of most value to experienced rather than new users. In particular, understanding and being able to use many of these features requires a certain level of existing knowledge and experience on the part of the user.

If there are areas where you feel that your current level of knowledge is lacking, you should either consult the full edition of the REAPER User Guide, or explore REAPER's comprehensive video library, or both.

REAPER 7.0: What's New

Table of Contents

Default Track/Mixer Panels: Dynamic Links (Not yet available).....	5
Arrange View Mouse Modifier Overrides.....	6
Power Editing with Mouse Modifier Overrides.....	7
Power Editing with Razor Edits.....	7
Power Editing with General Editing.....	8
Media Item Editing with Track Group Items.....	8
Fixed Media Item Lanes.....	9
Recording and Layering Media Items.....	9
Managing Items.....	10
Comping with Media Item Lanes.....	11
Editing Media Items.....	13
Sealing the Deal.....	13
Converting Takes to Lanes.....	13
Mouse Modifiers for Power Users.....	14
Preferences and Options.....	14
Gain Reduction Metering.....	15
Alternative Keyboard Shortcuts.....	16
Serial vs Parallel FX Chains.....	17
FX Containers.....	18
The Visual Track Spacer.....	20
Item Fade Default Settings.....	21
The REAPER Theme Adjuster (Not yet available).....	22
Video: Show Video from Background Projects.....	23
Animated Icons.....	24
Opening a File in Recovery Mode.....	24
Track Channels.....	24
ARA Pooled Edits.....	24
Envelope Color Overrides.....	25
Track Folders: Various Improvements.....	26
Drag and Drop Options.....	26
Context Menu Folder Options.....	26
Folder collapse track cycle options.....	27
Custom Toolbar Support.....	27
MIDI Editor: Settings.....	28
MIDI Editor: CC Lane Improvements.....	28
Rendering Formats: Raw PCM Data Supported.....	28
Enhanced File Backup Preferences and Options.....	29
Other Changes to Preferences.....	30
Project, Item Fade Defaults.....	30
Project, Item Loop Defaults.....	30
Audio, Scrub/Jog.....	31
Appearance, Loop/Lane recording.....	31
Project, Track/Send Defaults.....	31
Appearance, Envelope colors.....	32
Appearance, Track Control Panel.....	32
Appearance, Track Meters.....	32
Appearance, Zoom/Scroll/Offset.....	32
Plug-ins, ARA.....	33
Summary of main changes/additions to preferences.....	33

REAPER 7.0: What's New

REAPER 7.0: What's New

Default Track/Mixer Panels: Dynamic Links

This illustration shows REAPER's track controls. Their exact position may vary according to factors such as the track height and the track control panel width. Note that Record input and Input source are only visible when Record arm is enabled.

By default, not all of these controls will be visible in the TCP when you first start REAPER. This is because both the Arrange View and the Mixer are open and shown.

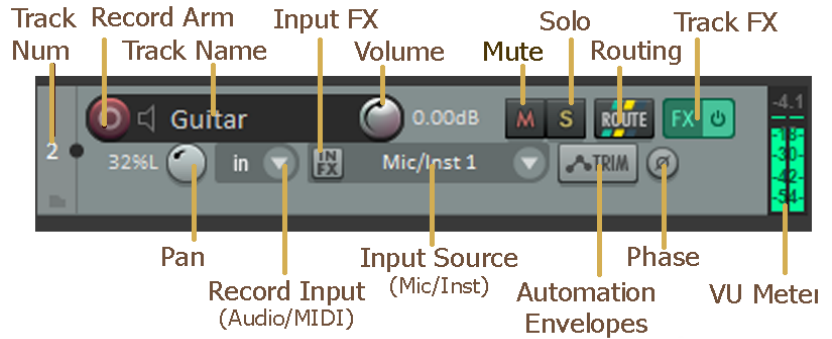

Since all the controls are visible in the mixer (below right) many users prefer not to show them all in the TCP as well. REAPER's default mixer and track panel layouts are dynamically linked: if you close the mixer (**Ctrl M**), all controls will then become visible in the track panel. Reopen the mixer (**Ctrl M**) and some track controls will again be hidden.

Especially if you are working on a laptop, or have only one monitor, in order to be able to make the best use of screen space you might wish to keep the mixer open only when you are needing to use it.

You can hover your mouse over any control for a tooltip. You click on a control to engage it (for example, click on the Mute button to toggle mute status of any track, click and drag on the Volume control to adjust the volume level), and right click on a control for a menu of commands, options and/or settings.

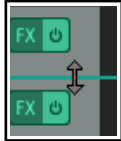

Some controls might not be visible because the track or mixer panel is not large enough to show them all. If so, you can increase the track panel width or height.

To enlarge the track panel, hover your mouse over the right or lower panel boundary (see left) so that your mouse cursor becomes a double headed arrow, then click-drag to the right or downwards.



To increase/decrease the height of the mixer panel, hover the mouse over the top boundary of the panel, as shown (left) then drag the boundary up or down.

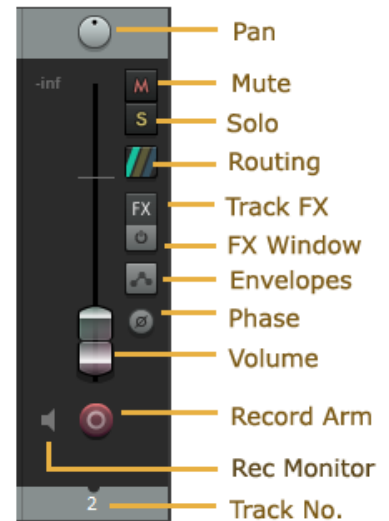

Depending on the track layout, the volume control may be a rotary control (as shown right) or a horizontal fader. All of these controls are explained further in the User Guide.



Note 1:

By default, the volume and pan controls work with audio items, not MIDI. To change this for any track(s), choose **MIDI track controls, Link track volume/pan to all MIDI channels** from the right-click menu.

Note 2:

REAPER comes with three different track and mixer layouts – A, B and C. By default, Layout A is used for both. Layouts B and C can be selected from the Options, Layouts menu. Note that B and C are by default not dynamically linked.

You can change this, as well as making other changes using the Theme Adjuster, which is discussed later in this guide.

REAPER 7.0: What's New

Arrange View Mouse Modifier Overrides

You might have noticed that there are no mouse modifiers listed for left drag in the arrange view category. This is basically because their actions are "hard-wired" into REAPER for some core tasks, such as:

Left drag	Remove any existing time selection and create new one
Ctrl Left drag	Create empty media item

However, REAPER recognizes that these might not be suitable for your particular workflow. For this reason, you can create up to four alternative sets of arrange view mouse modifiers – A, B, C and D.

By default:

- Set A includes options suitable for use with marquee.
- Set B includes options suitable for use with razor editing.
- Set C can be used in conjunction with fixed lane comping,.
- Set D includes options for making time selections.

You can, of course, change or modify any of these assignments, for example, if you prefer to use them in some other context.

Sets A and B are usually activated/deactivated from the toolbar.

Set C is usually activated/deactivated from the Fixed Menu lanes context menu.

There are also individual actions to activate/deactivate all four sets. Probably most useful are the **Toggle arrange view override mouse modifiers {A, B, C or D, as required} on/off**.

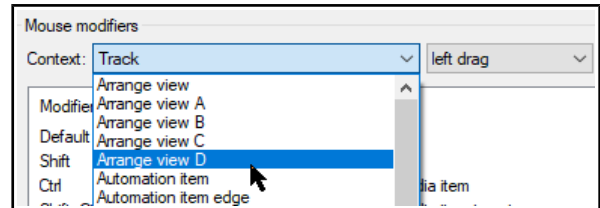

REAPER 7.0: What's New

Power Editing with Mouse Modifier Overrides

You have already encountered several of REAPER's mouse modifiers: these are what gives you the ability to use your mouse to perform so many tasks: for example, when razor editing – **Alt right drag** to make a selection, **Ctrl left drag to copy a selection**, and so on. There's a section dedicated to mouse modifiers in the user guide.

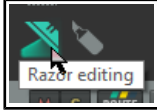

REAPER's mouse modifiers have to handle so many diverse tasks beyond just razor editing that finding your way around them can be a clumsy process. A solution to this is to be able to create your own alternative set of modifiers all relevant to a particular task (in this case razor editing), so that you can focus on that task alone.

By clicking on the razor edit toolbar icon (shown above) you are able to activate an alternative set of arrange view modifiers dedicated specifically to razor editing, all using the left mouse button. The button lights up and becomes animated. You can define the various modifiers as you wish.

Power Editing with Razor Edits

There are four alternative sets available (for different types of activity), but we'll get to C and D later in this guide. Razor editing uses alternative set B. **Options, Preferences, Mouse modifiers**, will open the mouse

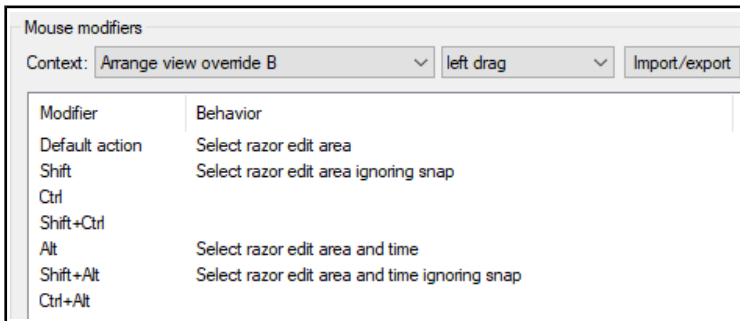

modifiers window. From the **Context** dropdown, select **Arrange view override B**.

As you can see, some tasks have already been defined – for example, **left drag** will **Select the razor edit area**,

You can change any of the default assignments, and/or assign tasks to those that are currently not used. For example, to change **Shift left drag** to **Add to the current selection** you would do this:

1. Double click in the Behavior column in the Ctrl row. This will display a menu of tasks and commands. Click on **Select razor edit area** then **Add to selection**.
2. Click on **Apply**.

Assignments can be made to currently unassigned modifiers (such as **Ctrl**) in the same way.

One benefit of this is that you can now do all your razor editing without needing to engage the right mouse button.

To remove any of your assignments, double click on it in the Behavior column and select **Default action**.

Note that REAPER's default assignments for other contexts – such as **Razor edit area** will still apply. For example, **Ctrl left drag** will still move a selected razor edit area. These assignments too can be changed if you wish.

To disable the Arrange View B mouse modifiers and restore REAPER's default assignments, simply click the razor editing button on the task bar again. The button will cease to be illuminated or animated.

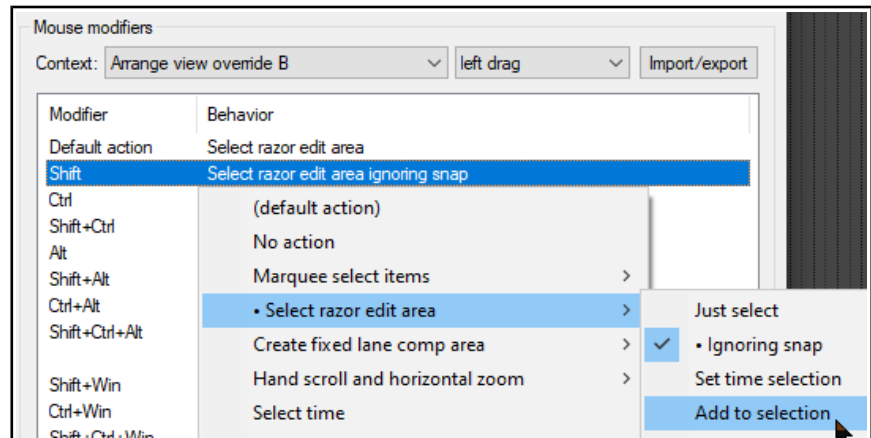

REAPER 7.0: What's New

Power Editing with General Editing

Power editing when using marquee is even simpler than it is for razor editing. Click on the marquee button on the toolbar to activate it. The button will become illuminated and animated as it activates Arrange view override A.

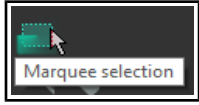

The various marquee tasks that you have been performing with your right mouse button can now be accomplished using the left button. Choose **Options, Preferences, Mouse Modifiers** and select **Arrange view override A** if you wish to change any of these.

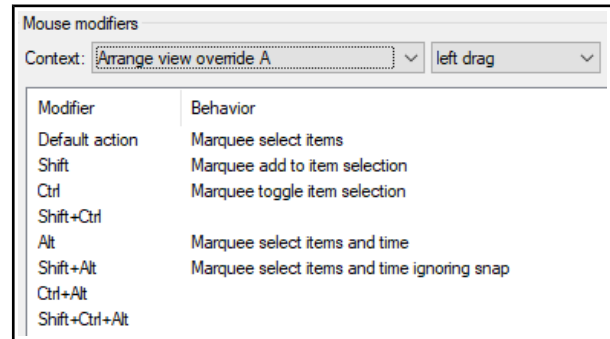

Also as with Arrange view override B, click on the marquee button again to deactivate it and restore REAPER's default assignments. The button will cease to be illuminated or animated.

Tip: Even if you prefer not to use these alternative mouse modifiers A and/or B for marquee/razor editing, you might still find them handy. There are many other tasks you can assign them to (e.g. scrolling, scrubbing), in which case they can be activated/deactivated from the Actions List and assigned to toolbar buttons.

Media Item Editing with Track Group Items

Here we are looking at grouping not track controls but media items within and across the tracks, so that an item selection can be edited together.

For example, you might want to adjust the item volume handle for a selection of items, or move or copy them together across several tracks.

Track item grouping behavior can in part be managed via the item and track media grouping tool on the main toolbar. Right-clicking over this tool displays the menu shown above.

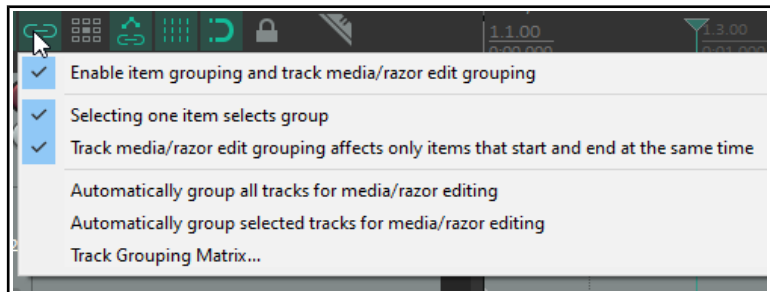

With REAPER 7, a new option has been added, **Track media razor edit grouping affects only items that start and end at the same time**. By default, this option is set to on.

REAPER 7.0: What's New

Fixed Media Item Lanes

Prerequisites: Before approaching this section, you will need a basic understanding of REAPER's recording techniques, and in particular layered recording. If necessary, you can refer to User Guide sections 3.1 to 3.5 and section 3.14. Familiarity with at least the basics of REAPER's legacy takes system is also recommended.

Media item lanes offer you a flexible alternative way of working that takes you beyond the limitations of REAPER's basic track structure.

By default, media items will fill the entire vertical space of the track on which they are recorded. If the media items overlap, they are auto-arranged vertically based on your preferences. The vertical positioning of media items does not affect playback. Media items that overlap

interact during playback according to the project settings (**Project settings, Advanced, Item mix behavior**), preferences settings (**Preferences, Project, Item fade defaults, Preferences, Appearance, Zoom/Scroll/Offset**), snap settings, and/or media item properties for item mix behavior (see right). If media item and project settings are different from each other, the media item setting will apply.

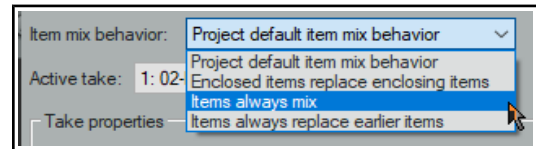

With free item positioning you can freely position and resize media items within the vertical space of the track. If auto-crossfade is enabled, media items that overlap vertically will crossfade. Otherwise, the vertical positioning of media items does not affect playback. The *preferences for item mix behavior are ignored*; items always mix on free item positioning tracks.

Fixed media item lanes offer you further tools and techniques for building projects. They can be used to record, layer, edit, manage and comp material. The simplest way to think of them is like being tracks within tracks. Up to 128 lanes can be recorded within a single track. As you will see, REAPER then gives you multiple options to treat these tracks individually or as linked (such as by comping) or in other ways related, as you wish.

Let's start with the basics! To give you some idea of where we're eventually going here is a relatively simple application of media item lanes:

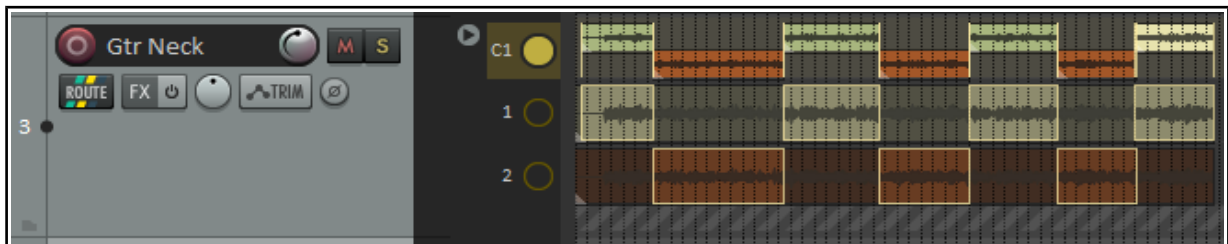

Look at the above illustration. Notice:

- ◆ The track shown comprises three lanes, labeled in a lanes panel (top to bottom) C1, 1 and 2.
- ◆ Lanes 1 and 2 are two takes of the same tune. Lane C1 is a work in progress comp of the best parts of lanes 1 and 2.
- ◆ To the right side of the track panel a new section has been added: this shows (in this case) three labeled buttons as well as housing its own right-click context menu.

Recording and Layering Media Items

Example

We can begin by working through a relatively straightforward example, to help understand the basics, then go on to consider more powerful and complex models.

1. Make sure that the following conditions are set on your **Options** menu:

Record mode normal

Offset overlapping media items vertically

New recording that overlaps existing media items then either **Add lanes** or (if you prefer) **Add lanes (layer new lanes)**. This latter option should only be chosen if you wish to play the new material along with any existing lanes.

2. Create a new, empty project file (**Ctrl N**). Add a track and either (using an instrument of your choice) record a tune for about a minute, or import an existing media file.

REAPER 7.0: What's New

3. Insert a new track after your recorded track. Expand its height to be similar to that shown above.
4. Now record, one at a time, two takes of a second instrument, to go with your first track, *both on the same track, one over the top of the other*. When finish, disarm the record button.

Your arrange view display should now be something like this (below right).

There's a lot here to explore, including those buttons, but first, let's make sure we understand what's happened.

Two separate media items have been recorded and are displayed in lanes one above the other. By default, only one item will play back: there are options to

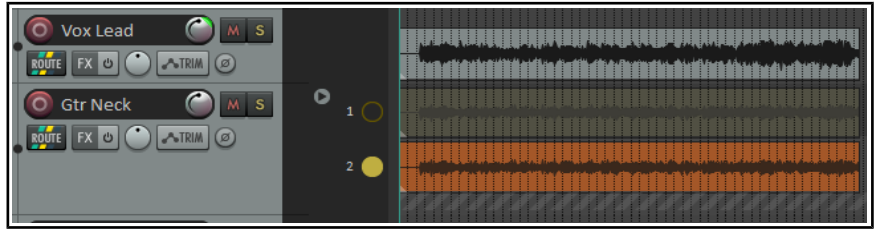

change this, for example, to play a selection of lanes, or all lanes. They each exhibit all the properties and features of any media item, for example:

- ◆ You can double click on any item to access and edit its media properties, such as pitch, pan, etc.
- ◆ Keep in mind that Options, Preferences, Appearance, Media will allow you, for example, to add a volume knob or FX button to items: you can then add FX and FX parameter envelopes.
- ◆ You can split items and edit individual segments independently of each other.
- ◆ You can set the default height for fixed item lanes to small or big (Options, Preferences, Project, Track/Send Defaults).

Managing Items

In this next section, we will look at managing and editing your media items.

Right click over (or just below) either of the buttons to display a context menu. Note that this includes a set of three playback commands – **Play only (selected) lane**, **Toggle playing lane** and **Play all lanes**. Where there are multiple lanes, you can select any number of lanes to be played back by **Ctrl click** on the lane names.

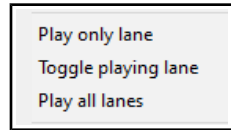

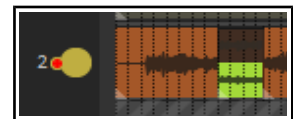

When layering, the tricks and techniques described below are at your disposal.

Menu option/Mouse option	Comments
Select playback lane(s) from menu	Click on a lane's button/Right click in lanes panel, select Play only lane , Toggle playing lane or Play all lanes from menu.
Select lanes to play	Click on first lane's button then use Ctrl click to build selection.
Select items	Selects all media items in currently selected lane.
Duplicate items to new lane	Copies all media items in currently selected lane into a new lane. You might use this, for example, if you have "dry" recorded material and you want to experiment with editing and/or FX, using the original dry material as a reference point.
Recording, Record into lane Recording, Record into first available lane Recording, Layer new lanes	Select lane for recording and choose Recording, Record into lane from menu. A red dot will be displayed. Can be used, for example, for overdub recording, as shown here. You can also enable Play only this lane . If Record into first available lane is disabled, a new lane will be created for every recording. If Layer new lanes is enabled then new lanes will play alongside any lanes that are already playing: otherwise the new lane is the only one that will be played.
Toggle a track's fixed item lane status on/off	Right click over the track's control panel and use the toggle command Fixed item lanes on the context menu.
Add empty lane at bottom	Adds lane as last lane in track. Media items can be dragged from elsewhere and dropped inside this lane.

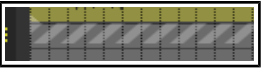

REAPER 7.0: What's New

Menu option/Mouse option	Comments
Insert new empty lane above this lane	Inserts an empty lane as specified. Use drag and drop to insert previously recorded media items into this lane. This could, for example, be a reference track to be played along with your newly recorded material. Alternatively, use Record into an existing lane to record into it.
Insert a media item into a new lane.	Drag and drop the item into the diagonally striped parking area located below the last lane. 
Rename lane	By default lanes will be named in sequence – 1,2, 3 etc. To rename any lane, right-click over the lane's button, choose Rename lane from menu, type the name and click OK .
Delete lanes (with sub-menu)	Options to Delete lanes (inc media items) , Delete all lanes with no media items , Delete lanes (inc media) that are not playing , Delete lanes (inc media) with no comp areas and Delete all lanes (inc media items) .
Automatically remove empty lanes at bottom of track	Will remove any unwanted empty lanes at bottom of track.
Item colors	Sub menu options to Set all items that share the same media source to the same random color or Set items in all lanes to one color per lane .
Click/Shift click on arrow to left of comp lane	Click to toggle between Make lanes big and Make lanes small . Shift Click to toggle Show all lanes on/off . 
Change selected lane when height is in collapsed state	Click on Up/Down arrows on the single displayed track button. 

Comping with Media Item Lanes

Using your mouse you can quickly and easily build a comp (or comps) from your media item lanes. One important difference between this and REAPER's legacy comping system is that *the material is comped into new items*. Your original items are not modified in any way.

To turn comping on in a new lane, from the lane panel's context menu choose **Comping, Comp into new empty lane**. A new lane will be inserted above the existing lanes. Shown here, it is labeled **C1** – **Rename lane** from the context menu lets you change this.

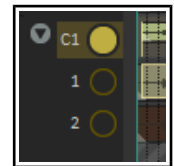

To toggle comping on/off in an existing lane, double-click on the required lane button.

It's a good practice to finish any edits on your source media items before you begin comping. **Comping, Allow editing source media while comping** can be toggled on/off from the context menu. Even with this option turned off you will still be able to perform edits on the contents of comped lanes.

Use left drag to define areas to be comped. Shown here an area has been selected from each of the two media lanes. They do not meet up. To fix this, simply drag the border on either of the two areas towards the other, as shown below left. You can then if you wish drag this border either left or right to adjust the relative comp areas, as shown below right.

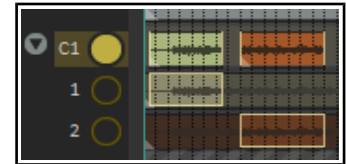

The vertical yellow marker lines in the comp lane can be used to adjust the borders between segments.

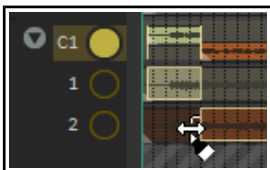

Note that these actions copy the comped segments as new media items. The items in comp lanes can be edited (e.g. by adding FX or fades) without affecting the original media in the source lanes in any way.

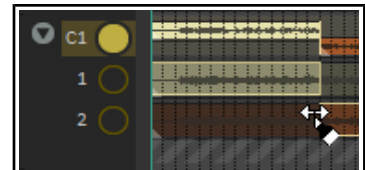

Below is a summary table of various comping tasks, commands and actions.

REAPER 7.0: What's New

Context menu command	Items in Comp Lane - Comments
Split comp area here	Splits comp area at current cursor position.
Delete comp area	Deletes comp area under mouse cursor and removes media from comp.
Delete comp area but not media items	Removes comp area but leaves media item in place.
Delete comp area edge	Removes edge line between two comp areas in same lane.
Add comp area at time selection	Adds a comp area matching current time selection.
Panel context menu	Comments (see also Managing Comp Lanes , below)
Comping, Delete comp area inc source media	Removes all comp areas from selected lane along with the actual media. Delete comp area alone will remove the comp area but leave media.
Comping, Turn off comping	Turns comping off. To turn it back on, use one of the Comp into ... commands explained below.
Track panel context menu	Comments
Fixed item lanes	Toggles fixed item lanes status on/off.
REAPER Options menu	Comments
Offset overlapping items vertically	Can be toggled off if you wish to show cross-faded comped material overlapping.
Snap/grid, Snap/grid settings	Toggle options to Snap media items to media items in other fixed lanes and Snap fixed lane comp area to media items .

Tip: Working with comp lanes can involve a lot of mouse movements, and especially dragging. It can be quite tricky at first, and you might find that slip up from time to time! A handy tip is to keep your **Undo History** window open so that if you do get into strife you can easily go back to your last known safe spot.

Managing Comp Lanes

To add additional comp lanes, from the context menu choose **Comp into a new empty lane**. You can drag and drop this new lane up or down the lane order.

To make a copy of a currently active comp lane for further editing either use the context menu command **Comping, Comp into a new empty lane, automatically creating comp area**.

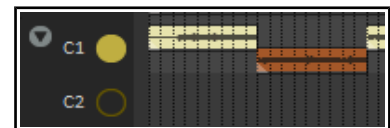

These commands, as well as **Comping, Comp into new copy of this lane**

and **Comping, Comp into this lane**, are also available on the track panel's right click context menu.

When you have multiple comping lanes you can change which one is active with **Shift Ctrl click** over the lane button.

To make an empty media lane into a comp lane, **Double click** on its panel button.

See **Mouse Modifiers for Power Users** for a full list of relevant mouse modifiers.

Mouse Gestures in Comp Lanes and Media Lanes

Remember that by default you can edit media items in comp lanes in the same way as other media items. To make this possible without interfering with your comping, you will see that comp lanes are horizontally divided into two areas.

When the comp lane is selected the larger upper area behaves like any normal track. You can make time selections, edit media items and so on by using your mouse in this area. The smaller lower area can be used for comping – for example, to drag and move comp borders.

For example, you can make a time selection in the upper area, then right click in the lower area within that selection and **Add comp area at time selection**. This will insert two yellow marker lines and create an empty area that you can fill later.

This will not apply to your media lanes if you have **Allow editing source media while comping** disabled.

REAPER 7.0: What's New

Editing Media Items

Ideally you'll want to finish media item edits before comping. However, the need might arise for you to make edits to one or more of your items after you have begun comping. In this case, you can enable editing using the context menu toggle command **Comping, Allow editing of source media while comping**. The display changes, as shown on the right. The top half of each source lane is where you make your edits. The bottom half highlights your comped segments, as shown here (right).

Your editing can include fades and/or crossfades. Any fades/crossfades applied to media in the source media lanes will also be applied in the comp lane. However, the fades in the comp lane can be edited independently if you wish, as shown here (below right). Double-click in the crossfade area if you want to access the crossfade editor.

It is possible that in making your edits your source item could now get out of sync with your comp lane. Happily, the area of the source lane that was originally copied to the comping lane will remain highlighted: clicking there is one way to restore the original comp area and remove whatever edits were made in that lane.

Another option is to use re-comping, which can be achieved by choosing **Comping, Copy edited media items to new lane and re-comp** (Shift left click) from the comp area context menu. This will preserve comp lane edits by moving them to a new source lane and creating a new comp area so that the edits are copied right back to the comp lane. Thus, the edits become a new source lane alternative which is available for you to use while comping.

When you have finished editing, remember to disable **Allow editing of source media while comping**.

Sealing the Deal

So ... you've finished editing and comping your media items, what now? You might wish to protect your comps from any accidental damage. You have a number of options. For example, two possibilities are:

- ◆ Right-click on the comp lane's control button and choose **Show only lane** from the context menu. This will collapse the track as shown here. Marquee all items in the comp lane, press **F2** to open the **Media Item Properties window**. Select **Lock** then **OK**. You can then use the track panel context menu to disable **Fixed Item Lanes** for this track. ... or ...
- ◆ Marquee all items in the comp lane **Ctrl drag and drop** to copy to a new track. With all items still selected, press **F2** to open the **Media Item Properties window**. Select **Lock** then **OK**. Use the **Track Manager** to mute and hide your original track.

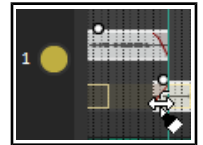
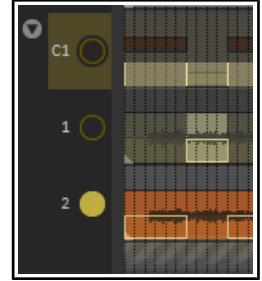

Converting Takes to Lanes

Existing tracks that make use of REAPER's legacy takes system can be converted into fixed item lanes. Select the track and from the right click context menu choose either **Fixed item lanes** or **Fixed item lanes (convert takes to lanes)**.

Thus this ...

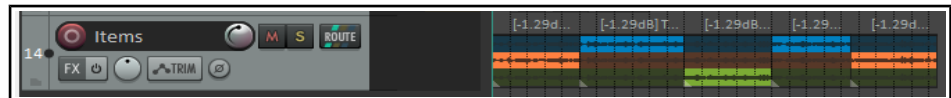

Becomes this ...



Then, after turning on **Comp into new empty lane**, this.



REAPER 7.0: What's New

Mouse Modifiers for Power Users

Below are summarised REAPER's default mouse modifiers and a sample of the many actions. Chapter 15 of the User Guide includes information about how these can be customized.

Mouse Modifiers

Fixed lane comp area – Left drag

Default action	Move comp area.
Shift	Move comp area ignoring snap.
Ctrl	Copy comp area and media item together.
Shift Ctrl	Copy comp area and media item together ignoring snap.
Alt	Move comp area and media items.
Shift Alt	Move comp area and media items ignoring snap.
Shift Ctrl Alt	Move comp area and adjacent comp area edges ignoring snap.

Fixed lane comp area – Left click

Default action	Move comp area to lane under mouse.
Shift	Comping, Copy edited media items to new lane and re-comp.
Alt	Delete comp area including media item.
Shift Alt	Heal comp area with previous adjacent comp area in same lane
Ctrl Alt	Delete comp area but not media item.
Shift Ctrl Alt	Extend comp area to next comp area or end of media.

Fixed lane comp area – Double click

Shift	Set loop points to comp area.
Ctrl	Extend comp area to next comp area or end of media.

Fixed lane header button – Left click

Default action	Play only this lane.
Ctrl	Toggle playing this lane.
Alt	Play only this lane while mouse button is pressed.

Fixed lane header button – Double click

Default action	Comp into lane.
Shift	Select items in lane.
Ctrl	Toggle playing this lane.
Shift Ctrl	Insert lane.
Alt	Delete lane (including media items).

Fixed lane comp area checkboxes: The two checkboxes to avoid empty track space when clicking source lane and when mouse editing a comp area can be enabled to limit comp area edits to within media item edges.

Assignable Actions

The actions list includes numerous fixed lane comp area actions which can be assigned to keyboard shortcuts, or toolbar buttons, or as mouse modifiers. Here is a brief summary of categories. For more detailed descriptions of options, see the Actions List (**Actions, Show actions list**).

Add comp area for lane under mouse

Move comp area up/down

Set loop points

(inc with half or one second
preroll/postroll)

Split comp area

Split media items

Move comp area

Razor edit: create comp area

Copy comp lane items

Move items down to next available lane

Delete lanes

Turn comping on/off

Explode takes on selected tracks to fixed lanes

Preferences and Options

REAPER's Appearance, Track Control

Panel preferences settings include an option to specify default behavior when clicking on the fixed lane collapse button. This can be set to toggle between showing one or many lanes, and displaying big lanes or small lanes.

In **Project, Track/Send Defaults** there is an option to make fixed item lanes the default for new tracks.

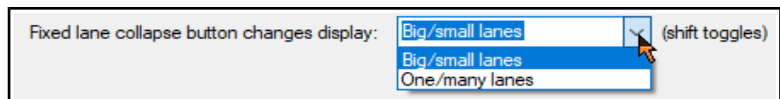

REAPER 7.0: What's New

Gain Reduction Metering

The mixer Master Track main controls have the same functions as the Master Track which can be shown via the Track Master in track view.

Gain reduction metering is now available as an option.

- Left click on the Output button (shown above right) to toggle between Stereo (gray) and Mono (orange) modes.
- Right click on the Output button to set any one of four available Mono modes – Left + Right, Left only, Right only, Left - Right.
- Left click on the FX button to display the master FX Chain.
- Right click on the FX button for the Add FX context menu.
- If the Master FX chain is displayed you can use any of the FX management keyboard shortcuts that you can use on your tracks.
- Right click on the VU area to display controls to manage the VU meters display settings (right). Meter options for the master when displayed in the TCP are Peak or Loudness: for the mixer, these are Peak + Loudness (as shown here), Loudness Only or Peak only. Options for loudness meter display are:
RMS (Root Mean Squared) stereo/max *or* RMS/Max only
Loudness Units relative to Full Scale momentary (LUFS-M)/max
LUFS-M/LUFS-I (integrated) LUFS-S (short term) /current
LUFS-S/ max (loudness range) LUFS-S/LRA
- Optionally, you can choose for gain reduction to be displayed on the meter (as a vertical bar descending from the top, as shown below right). This can only be shown when you are using a third party or native plug-in (such as ReaLimit) that calculates gain reduction and reports it to the host.
- Readout can be set to LUFS-I or Maximum.
- LUFS, RMS and Peak issues are explained in Chapter 6 of the User guide.
- There is an option to display multichannel peak metering.
- Settings, where appropriate, available for managing the window include RMS window, Display offset, Display gain and Red threshold.
- This includes the option to display output in multichannel mode (e.g. when working with surround sound). Disabling this option will ensure a two channel display.

Loudness meter settings include:

Meter display: Stereo RMS, Combined RMS, LUFS-M, or LUFS-S.

RMS Window: the length of time (in milliseconds) that should be used for RMS calculation.

Display offset: this offsets the coloring of the RMS metering while keeping the position constant.

Display gain: this applies gain to the RMS meter value: for example, if you set display gain to, say, 6dB, a sine wave will show the RMS value at a higher meter reading than the peak value.

Red threshold: this determines the level at which the meter will turn red.

In the example shown above, if you were targeting -14dB LUFS or RMS, then with display offset at 14dB the display would go green at -14dB, and with red threshold 4.0dB, it would go red at -10dB.

Note: There is an option in **Appearance, Track Meter** settings to scale gain reduction from plugins by a level that you can specify.

Track Gain Reduction Metering:

Track gain reduction monitoring for plug-ins that measure gain reduction and report it to the host can be enabled in **Preferences, Appearance, Track/Send Defaults**. Display the **Track meter display** dropdown and enable **Display gain reduction for plug-ins that support it**.

Track meter defaults will be applied to new tracks only, not to existing tracks on existing projects.

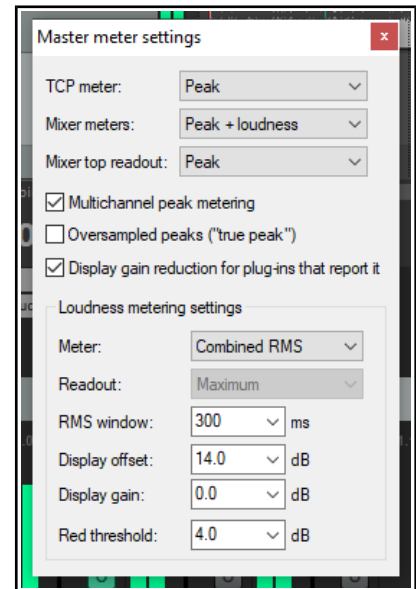

REAPER 7.0: What's New

Alternative Keyboard Shortcuts

The different action list sections can be used in different environments. In most cases, these present you with the actions (for example, when you are recording) that are most relevant to the particular context.

These are **Main**, **Main (alt recording)**, **Main (alt-1 thru Alt-16)**, **Media explorer**, **MIDI editor**, **MIDI event list editor** and **MIDI in-line editor**.

Having separate sections for different environments lets you assign the same shortcuts to different actions in different environments.

Various combinations of keys could be used in the MIDI editor to select what is displayed in a CC lane. That same set of shortcuts could be used, say, in the MIDI Event List Editor to determine which channels are displayed, and, say, in the Media Explorer to browse thru various folders. None of the assignments that you make in any of the other sections will have any impact on keyboard shortcuts in the Main section.

The options for alt-1 to alt-16, however, require further explanation. They allow you to determine keyboard shortcut behavior in various *contexts* rather than *environments*.

No two people's needs are likely to be the same, so let's look at a couple of simple examples. Try not to focus on the actual examples (which might or might not be relevant to you) but rather on the technique.

By default **S** will split selected media items or, if no item is selected, all media items, at the current cursor position. There will be times when this might be what you want, but other times, perhaps at a certain stage of tracking, when you might prefer to use **S** to solo/unsolo a currently selected track.

Likewise, at that same stage of your project you might not yet be ready to worry about markers and will prefer to use **M** to mute/unmute a currently selected track, rather than create a marker.

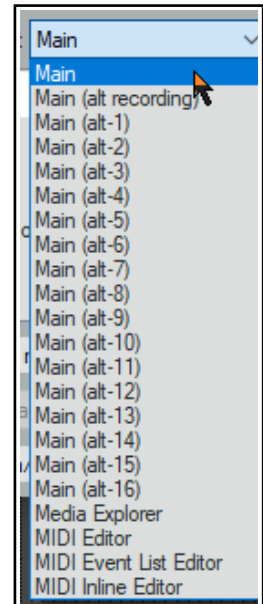

Example

You will want to create a shortcut for switching between the different shortcut sections, and also override the REAPER's default settings where necessary. With any project open, this is how this could be done:

1. Open the **Actions** window.
2. Find the action **Main action section: Toggle override to alt-1**. Select it.
3. Click the **Add** button, press **Alt 1**, then **OK**, and **OK** again to **Override mapping**.
4. With the **Actions** editor open, from the section drop down list select **Main (alt-1)**.
5. Find the action **Track: Toggle solo for selected tracks**.
6. Click the **Add** button, type **s** in the Shortcut edit box, click **OK**. Again click **OK** to **Override mapping**.
7. Find the action **Track: Toggle mute for selected tracks**.
8. Click the **Add** button, type **m** in the Shortcut edit box, click **OK**. Again click **OK** to **Override mapping**.
9. You could continue to define more custom shortcuts for this section, but we'll leave it at that for now.
10. Make sure the **Main** section is selected. Close the **Actions** editor.
11. Press **m**. A marker will be inserted. Press **Ctrl z** to undo. Select any track.
12. Press **Alt 1**. Now press **m**. The currently selected track will be muted. Press **m** again to unmute.
13. Press **s**. The track will be soloed.
14. Press **v**. A volume envelope is added – this action has been passed through from the main section.
15. Press **Alt-1** to restore the main action list.

Tip: You can create custom icons for actions that alternative keyboard sets and add them to your toolbar. A single mouse click would then be all that was needed to toggle these sets on and off.

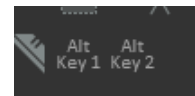

Note: In the above example, we have defined the keyboard shortcut **Alt 1** to toggle keyboard shortcuts between **Main** and **Main (alt-1)** but we don't seem to have added this definition in the **alt-1** section as well. This is because any and all keyboard **Main** section shortcuts that are *not* defined in an alternative section are automatically passed thru to the alternative sections. In this case, for example, **Ctrl S** in the **Main (alt-1)** section would still save the project, **Ctrl Z** undo, and so on.

REAPER 7.0: What's New

Serial vs Parallel FX Chains

By default, the plugins in a track or item FX chain are processed in serial – that is, one after each other. For example, if you insert both ReaEq and then ReaComp into an FX chain, the audio is passed first through the EQ FX. With EQ added, it is then passed through the compressor. This concept is illustrated on the right. This is how most often you are likely to want to have your FX processed.

However, there may be instances when rather than processing effects in serial you wish to process them in parallel. That is, you wish to process two or more effects (in this example, EQ and compression) each independently of the other, with the separately EQ'd and compressed audio then mixed back together. Using this method, you can avoid applying the compressor to the EQ'd signal.

This concept is illustrated in the second diagram on the right.

The steps required to run two effects in parallel are simple:

- ◆ Insert both of the FX into the track or item's FX chain.
- ◆ Right click over the second of these FX and from the context menu choose **Run selected FX in parallel with previous FX.**

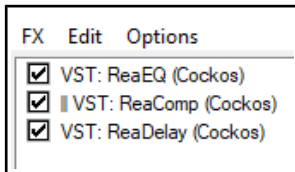

This is illustrated in the chain shown on the left. The two vertical parallel lines indicate that the audio stream will be processed by ReaEQ and ReaComp in parallel before being passed on through ReaDelay.

This technique can be used in any number of cases to explore creative effects. For example, you could use it

to apply reverb and compression independently of each other to an instrument, or two separate instances of compression to a vocal.

Parallel FX processing can also occur within more complex models. Consider the third illustration shown on the right.

Here we have four FX in a chain: the audio is first processed through FX1, then FX 2 and FX 3 (and only FX 2 and FX 3) are processed in parallel. To achieve this, FX 3 (and only FX 3) needs to be set to run in parallel to its immediately previous FX. Finally, the signals for FX2 and FX3 are merged and passed through FX 4.

More complex models are available: more examples, including FX containers, are considered in the next section.

Note: If MIDI items are being processed through midi FX in parallel which filter their own events you should instead use the command option **Run selected FX in parallel with previous FX (merge MIDI)**. This should prevent MIDI data from being excluded.

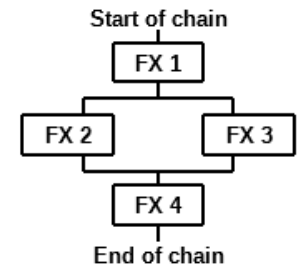
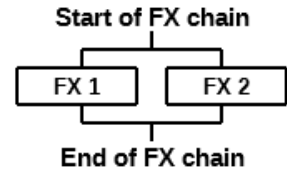
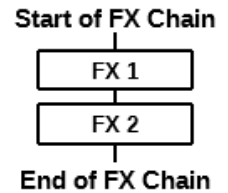

REAPER 7.0: What's New

FX Containers

Introduction

This advanced topic is not really suitable for beginners.

REAPER's FX containers allow you more flexibility and a greater capability in creating and managing FX chains than simply running two or more FX in parallel with each other. This advanced topic might take a little longer for you to get your head around. It's more appropriate for experienced users than for beginners.

To understand FX containers and how they work, let's take an example. The actual FX used are for illustration only and are not the focus of the exercise. What matters is the technique, which could be applied using other FX. We will build two parallel FX chains rather than just two parallel FX. This concept is illustrated by the diagram on the right. To achieve this, REAPER will need to:

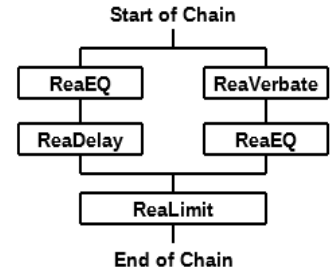

- ◆ Pass the audio signal into a *container*.
- ◆ This container will need to consist of enough channels as are needed to allow for (in this case) two parallel chains, i.e. four channels in all, one pair for each chain.
- ◆ As the audio stream exits the container, the outputs of the two parallel channels will need to be merged as they are passed on thru channels 1/2 of the FX chain to any subsequent FX (in this example, ReaLimit). To recap, channels 1/2 are used by default by the track to send audio output to the master.

So, to summarize, a container will need enough inputs and enough channels (in this example, four) to allow the different streams to be processed independently of each other, and enough outputs (again, in this case four) to allow the streams to be merged as they exit the chain.

That's a lot of theory to take in! Let's see how it's done in practice.

Example 1

To set up the FX container described above:

1. Click on the track's **FX** button, then **Add**, then from the displayed list of FX double-click on **Container**. A container is added to the FX chain and its empty window displayed. Immediately after the container, in the far left column, add **ReaLimit**. Select the container. Your FX window should now resemble that shown on the right.
2. Click on the *container's* button labeled **2 in+out** to open its pin connector window. Here you can define its parameters. We'll get to the pin connectors shortly. First, notice that by default the container inherits the same number of input/output channels as the track – in this case two.
3. Set the number of container channels, inputs and outputs to (in this example) 4 and complete the pin connector matrix as shown here (right). Instead of 2 in+out, the container's pin connector button will now read **2/4 in+out**.
4. This directs input from track channel 1 to container inputs 1 and 3, and from track channel 2 to container inputs 2 and 4.

Output from container channels 1 and 3 will pass to track channel 1, and output from container channels 2 and 4 will pass to track channel 2.

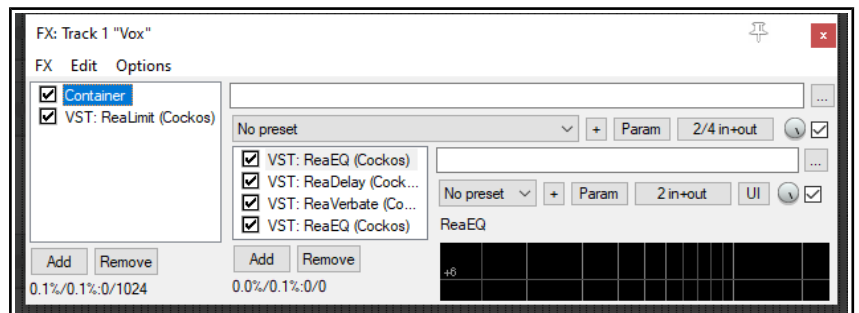
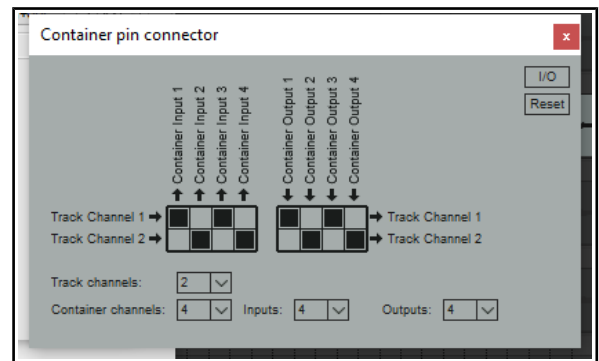
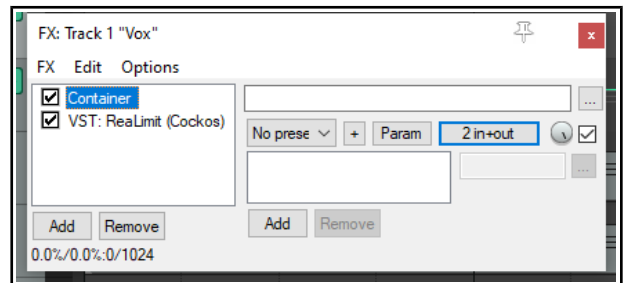

REAPER 7.0: What's New

- Using the **Add** button *in the container* window we can now insert the required FX into the container's FX chain – for this example ReaEQ, ReaDelay, ReaVerbate and a second instance of ReaEQ. Your FX window should now resemble that shown (above).
- The pin connectors for the first two container FX will both need to be set to receive input from and send output to container channels 1 and 2 only, as shown here (below left).
- Similarly, the pin connectors for other two FX will both need to be set to receive input from and send output to container channels 3 and 4 only (below right).

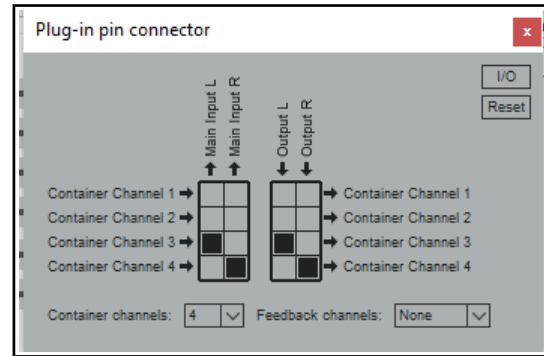
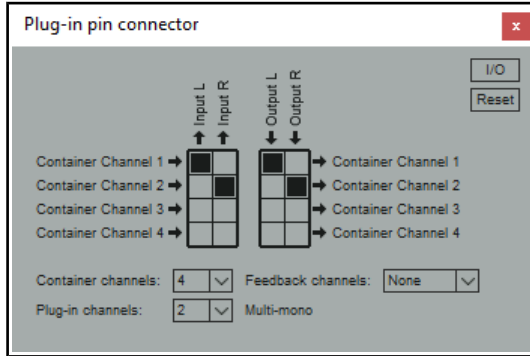

- Finally, you can experiment with adjusting the various FX parameters – and save this file as a model that you might find useful for future use.

Note: A new container can be added to an existing FX chain by choosing **Add FX container** from the FX menu. You can also create a new container from this menu by selecting any FX or selection of FX in the chain and choosing **Move to container** from the FX menu.

Example 2

In this example we will split an audio stream into two chains – left and right – and apply separate FX to each stream before returning the signal to the FX chain, one FX to channel 1 (left) only and the other to channel 2 (right) only. A possible application for this technique could be on a vocal, using one EQ instance to add body, the other to add clarity.

In this case, the pin connector numbers should be left at its default settings – two container channels, two inputs, two outputs.

The pin connector settings for each of the two EQ instances could then not be simpler. The first takes its input from and sends its output to channel 1 only (as shown here).

The second takes its input from, and sends its output to, channel 2 only.

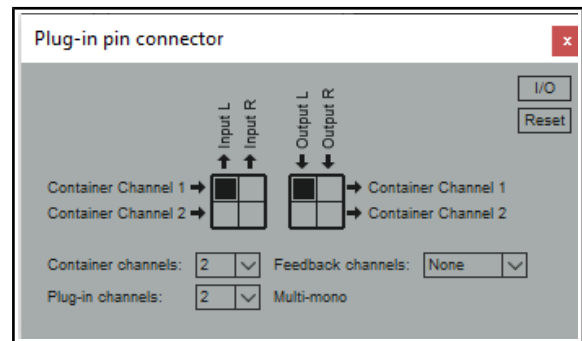

More Complex Applications

FX containers are handy, but even they do have their limitations!

More complex models can be created using REAPER's pin connectors – for example, fine tuning your parallel processing requirements, or directing the output from some FX to a different track. For these and other related topics refer to the **JS: Channel Mapper-Downmixer** in the REAPER User Guide.

Tip 1: FX containers can be even more powerful when combined creatively with other REAPER features. For example, you can have two or more containers running in parallel with each other!

Tip 2: You can select any FX or number of FX in a track or item's FX chain, then choose **Move FX to container** from their right-click context menu to move those FX into a new container.

REAPER 7.0: What's New

The Visual Track Spacer

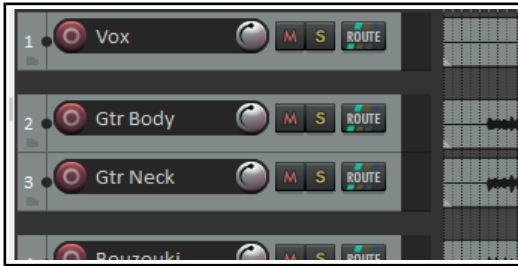

REAPER's visual track spacer can be used to insert a spacer between any tracks, as required. This can be helpful in easily identifying in a project tracks which belong together, or simply to prevent screen clutter. A simple example is shown here.

Shown left are a vocal tracks and two guitar tracks. A space has been inserted above the first guitar track (track 3) to visually separate the guitar tracks from the other tracks.

Default track spacer height is 16 pixels: you can change this value in your **Options, Preferences, Appearance** settings.

Spacing is added in arrange view by right clicking over a track's track panel and choosing **Virtual spacer** from the context menu. Options are to add a spacer before or after the track, or both, or to remove existing spacers.

To add a spacer after or before a number of adjacent tracks, simply select all of the required tracks and right click over any one of their track panels: choose **Virtual spacer** from the menu, then make your selection as before.

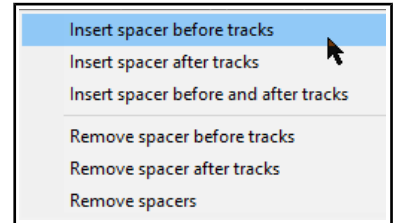

Track Manager								
	#	^ +	Name	TCP	MCP	S	M	Spacer
<input type="checkbox"/>	1		Vox	.	.			
<input type="checkbox"/>	2		Gtr Body	.	.			—
<input type="checkbox"/>	3		Gtr Neck	.	.			
<input type="checkbox"/>	4		Bouzouki	.	.			—
<input type="checkbox"/>	5		Percussion	.	.			

Note that if multiple tracks are selected, the space will be added before the first track in the selection, or after the last track, or both, depending on your menu selection.

A quick and easy way of adding or removing spacers between tracks is within the **track manager**. The track manager is covered in detail in Chapter 12.

For now, note that spacers can be added above any track or tracks. Simply click in the Spacer column for each track where you require spacing to be added: click again to remove the spacing (see above left).

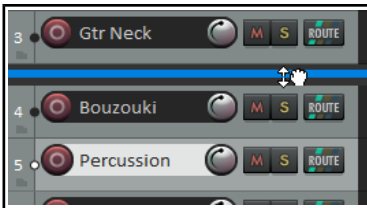

If you are moving a track or track selection up or down the track order, you can drop the track below a spacer to place it after the spacer, above a spacer to place it before the spacer, or in the middle of a spacer (as shown here) to show spacers both above and below it.

To **move** a spacer from one track to another, use **Left drag** up or down. To **copy** a spacer from one track to another, use **Ctrl left drag** up or down.

REAPER 7.0: What's New



Item Fade Default Settings

Separate fade/crossfade settings can be set for imported media items, split media items, recorded media items and fixed lane comp areas – **Preferences, Project, Item Fade Defaults**.

A new option has been added to **Apply fade-in/fade-out/crossfade to MIDI items**. These will include project auto-crossfade settings.

Note that fades on MIDI items are applied to velocity, not to volume.

The screenshot shows the 'Item Fade Defaults' dialog box. It is titled 'Defaults for media item fades/crossfades'. The settings are as follows:

- Default fade-in/fade-out: 0:00.010 ms
- Default crossfade: 0:00.010 ms
- Default fade-in/fade-out shape: 
- Default crossfade shape: 
- Imported media items: Fade-in/fade-out
- Recorded media items: Fade-in/fade-out, No crossfade (dropdown)
- Split media items: Fade-in/fade-out, No crossfade (dropdown)
- Fixed lane comp areas: Fade-in/fade-out/crossfade
- 'Trim content behind media edits' enabled: Respect toolbar auto-crossfade button (dropdown)
- 'Trim content behind razor edits' enabled: No crossfade (dropdown)
- Limit split-created fade/crossfade to: 50 pixels
- Right-click on crossfade sets fade shape for only one side of the crossfade (shift toggles)
- Apply fade-in/fade-out/crossfade preferences to MIDI items

REAPER 7.0: What's New

Video: Show Video from Background Projects.

New command on Projects Tab right click context menu to:

Display video from background projects if active project lacks video

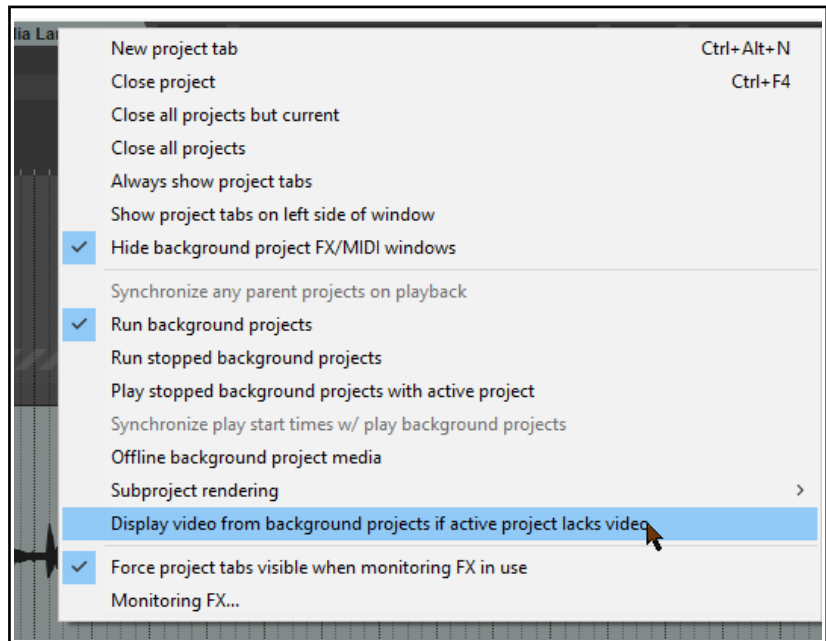

REAPER 7.0: What's New

Animated Icons

Some icons on your toolbar are animated by default. Most icons, including toggle icons and those that you add yourself, can be animated if you wish. The main exceptions are tools that simply execute as command, such as new project. The item grouping and move envelope points with media items tool are animated by default, but you can turn this off if you wish.

Toolbar animation is managed within the **Customize menus/toolbars** dialog.

1. Right click over the toolbar background area and choose **Customize toolbar ...** from the menu. This will open the Customize menus/toolbar dialog with **Main toolbar** selected.
2. Right-click on the name of the tool that you wish to modify. From the context menu choose **Highlight with animation based on toggle state**.
3. A submenu of options will be displayed. These are explained below.
4. Make your choice or choices from this submenu.
5. Click the **Apply** button. When you have finished making your changes click on OK.

Animation submenu options

Do not animate, Animate if toggle state enabled, Animate if toggle state disabled: these three options are self-explanatory and mutually exclusive. Select whichever you require.

Highlight animation or Armed animation: you can select either one of these visual effects, or one of the blink options.

Slow blink or Fast blink: these cause the selected tool to blink, or flash, between two different color states. In the default theme these are red and green.

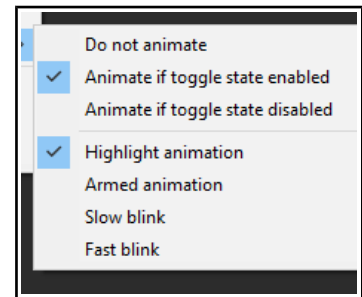

Opening a File in Recovery Mode

Any computer program will crash given the right (or wrong?) circumstances. This can be because of a problem with some third party plug-in. If this happens, you should enable the option to

Open with FX offline (recovery mode) when re-opening the file from the **File, Open project** dialog box (see right).

This will open the file with all FX set offline.

By reintroducing them online one at a time, you should be able to identify which one is causing the problem. To then fix the problem you should remove this plug-in and replace it with another of equivalent functionality.

Another method is to hold down **Alt** while you open a file from the **File, Recent projects** menu.

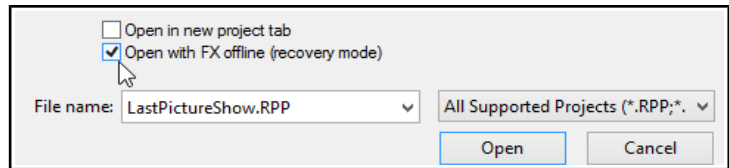

Track Channels

REAPER now supports up to 128 channels for routing, etc.

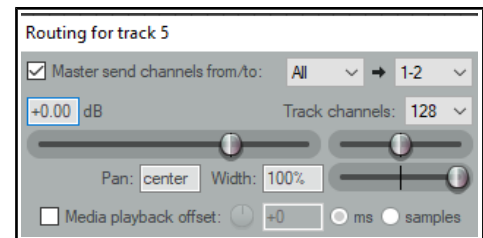

ARA Pooled Edits

REAPER now supports ARA pooled edits.

Options, Preferences, Plugins, ARA

See Melodyne documentation for more information about editing.

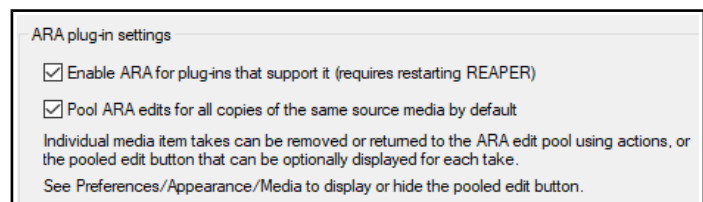

REAPER 7.0: What's New

Envelope Color Overrides

Envelope color overrides offer you a greater capability to customise the colors used for your envelopes. To use it to its full extent you will need to understand something about boolean logic, explained in Chapter 6.

To access this feature, choose **Options, Preferences, Appearance, Envelope Colors**.



The number of ways in which this can be used is almost limitless, and everyone will have their own ideas. Here are some examples.

To create an override rule, click the **Add** button then create your definition. Here are two simple examples.

You might use a variety of compressors and often need to automate ratio and threshold. You can define a color override so that ratio and threshold envelopes always use your preferred color, regardless of the actual plug-in.

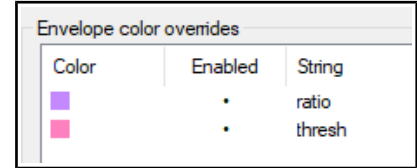
1. Click on the **Add** button. You will be asked to type a name. Type **ratio**, click **OK**.
2. Double click on the color shown, select your color and click **OK**.
3. Click again on **Add**, type **thresh**, click **OK** pick a color as before and click **OK**.
4. For both of these, if Enabled is not selected by default, click in the **Enabled** column to enable them. You should see a mark (as shown on the right).
5. Now add a compressor of your choice to any track and add envelopes for both ratio and threshold. They should conform to your color choices.





Color	Enabled	String
	<input checked="" type="checkbox"/>	ratio
	<input checked="" type="checkbox"/>	thresh

Let's get a bit more clever.

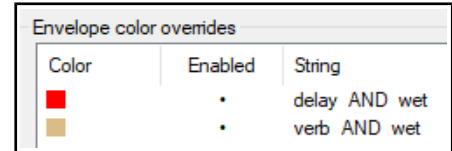
We might use delay and reverb often in our mixes, and also often want to automate the wet parameter. We also want to color code the envelopes so it is visually obvious whether this is a delay envelope or a reverb one. The rules shown here (right) will achieve this. **Note that you will need to type spaces both before and after the AND.**



Color	Enabled	String
	<input checked="" type="checkbox"/>	delay AND wet
	<input checked="" type="checkbox"/>	verb AND wet

Now let's throw a spanner in the works! Suppose your FX library includes a reverb plugin that doesn't have "verb" in its name? Let's call it "SuperDooop." What then? You can edit the rule to allow for this!

We amend the second rule to read:

(Super OR verb) AND wet

Note that a space is required after opening and before closing brackets. Spaces are required before and after the OR and the AND.

You can also use a NOT operator. For example, look at these two rules:

gain AND rea and
gain NOT rea

This would allow you to apply separate color coding to a Gain parameter depending on whether it is one of the Cockos Rea plug-ins or not.

That should give you enough ideas to get you started! The better your understanding of boolean logic, the greater use you will be able to make of this facility.

Note also:

The **Remove** button will remove a currently selected rule from the list.

The **Export** button can be used to export your current overrides to a .EnvColorList file.

The **Import** button can be used to import any previously exported color list file.

Note: If (presumably in error) two or more of your rules contradict each other, then REAPER will apply whichever one is higher up in the list.

REAPER 7.0: What's New

Track Folders: Various Improvements

Drag and Drop Options

One way of creating folders is by dragging and dropping. You identify which track is to be the folder, which are to be its children, then select and drag and drop the children into the folder.

This method can be rather tricky unless you are precise in your mouse movements. You might recall that in **Section 2.28 Managing Tracks of the REAPER User Guide** we saw that dragging and dropping track panels up or down the track display can move them and park them in a new position. This time, however, that's not what we want.

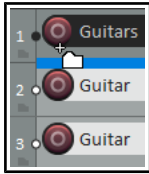

The trick is to drop the tracks inside a small drop zone used for creating folders. The exact area and size of this drop zone will vary with track height and track width: as a guide, think of it as being a rectangle that extends from the bottom left corner of the track panel just over half way up the track height and to its right by just under a quarter of the track width.



You'll know when you're there because the mouse cursor will display a folder (as shown above left) rather than a hand (as shown above right).



Tracks 3 and 4 have been selected and dragged up to Track 1, which is to be their folder container track (left).

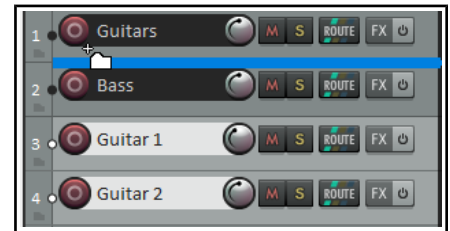

However, the mouse still displays a hand. If we were to release the mouse now, they would simply be moved to immediately below Track 1.

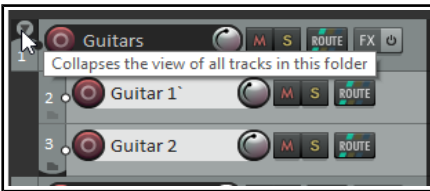

Instead, we move the mouse cursor left into the folder drop zone, so that it changes from a hand to the image of a folder (above right). We release the mouse, and the two guitar tracks are now placed inside a new folder (left), with Track 1 as the containing folder track.

Note: You can start your drag and drop from any part of the track panel (apart, of course, from the controls themselves), but to place the

tracks into a folder you must move the mouse cursor to the folder drop zone before releasing it.

Notice the small down pointing arrow just above the track number of the folder track (in this case Track 1). By default, this can be used to toggle the display of child tracks in the folder between **normal** (as shown by default), **minimized** and **collapsed**. Shown below is the same folder with its child tracks collapsed.



If you prefer not to use this method for drag and drop there is another option available. You can go to **Options, Preferences, Editing Behavior, Mouse** and turn on **When reordering tracks via drag and drop, hold shift key to control folder creation**. Then click **OK**.

Simple drag and drop will still move tracks: holding **Shift** while doing so will create a folder and place adjacent tracks into it. There will be no need to identify or use a folder drop zone – anywhere in the track panel will do.

Context Menu Folder Options

Another option for moving tracks into folders can be found on the track panel context menu. The panel's context menu includes a **Move to folder** command that will place a selection of tracks into a new or existing folder.

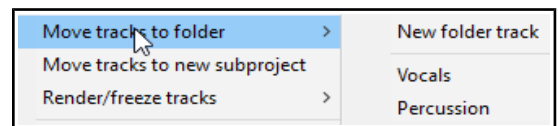

First, select the tracks that you wish to move into a folder, then from the right click context menu choose **Move tracks to folder**. You can then select from the list of existing folders or choose **New folder track** to insert the tracks into a new as yet unnamed folder, immediately above the first track in the selection.

You can then name the folder track by double-clicking in its name area.

REAPER 7.0: What's New

Folder collapse track cycle options

In **Preferences, Appearance, Track Control Panel** there is an option to include **hidden** in the cycle options (see below). This allows you to hide child tracks altogether.

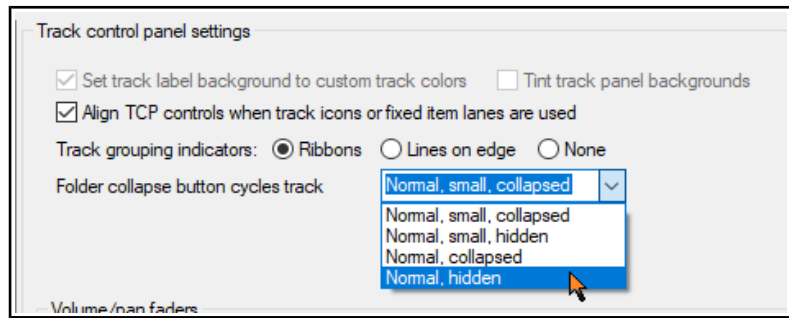

Custom Toolbar Support

REAPER supports up to 32 general and 16 MIDI only additional toolbars that you can set up to suit your particular requirements. By selecting which commands or actions are added to these toolbars you are able create one click access to your most important commands and actions.

Detailed information and instructions as to how to set up and use custom toolbars are included in sections 15.23 to 15.27 of the REAPER User Guide.

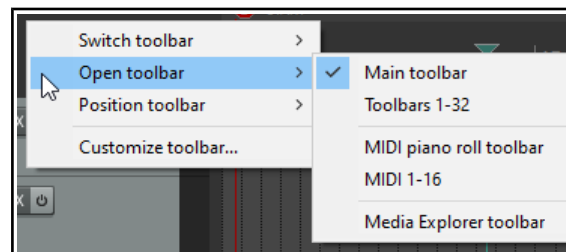

REAPER 7.0: What's New

MIDI Editor: Settings

Option added (**Options, Preferences, Editing Behavior, MIDI Editor**) for when using one MIDI editor per project for active MIDI item to follow selection changes in arrange view. This can be set to on a per track basis or per media item basis.

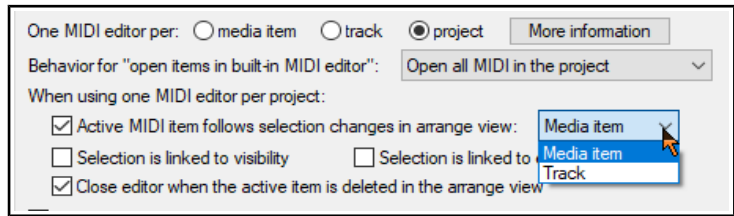

MIDI Editor: CC Lane Improvements

The File menu has new commands to **Rename last clicked note** and **Rename last-clicked CC lane**.

The CC Lane dropdown menu includes **Set lane (lanes with events)** which will display a list of all lanes that already contain data, whether they are currently displayed or not. Shown here, this includes Velocity, Off Velocity and Pitch. Select one to display that lane.

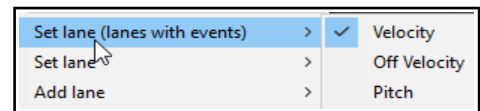

When using the pitch lane, you can set a custom pitchwheel range (in semitones), by right clicking over the text "Snap" and typing a number. Optionally, you can also engage the snap option.

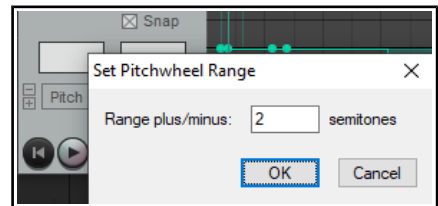

To scroll through the list of available CC lanes: to do this, hover your mouse over the currently displayed name and scroll with the mousewheel (see left).

For vertical zoom within a CC lane use Ctrl Mouse wheel: for horizontal zoom use Ctrl Alt Mouse wheel. For horizontal zoom use Alt Mousewheel.

Rendering Formats: Raw PCM Data Supported

Render to File dialog now allows you to choose Raw PCM data as either your primary or secondary output format.

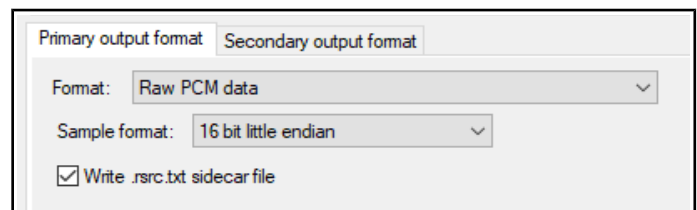

REAPER 7.0: What's New

Enhanced File Backup Preferences and Options

Make yourself familiar with the various backup options described here.

Good management of backup procedures can achieve the twin objectives of keeping secure copies of your projects and media files without overloading your disk(s) with unnecessary file clutter.

By default, when you first install REAPER these options are all set to off.

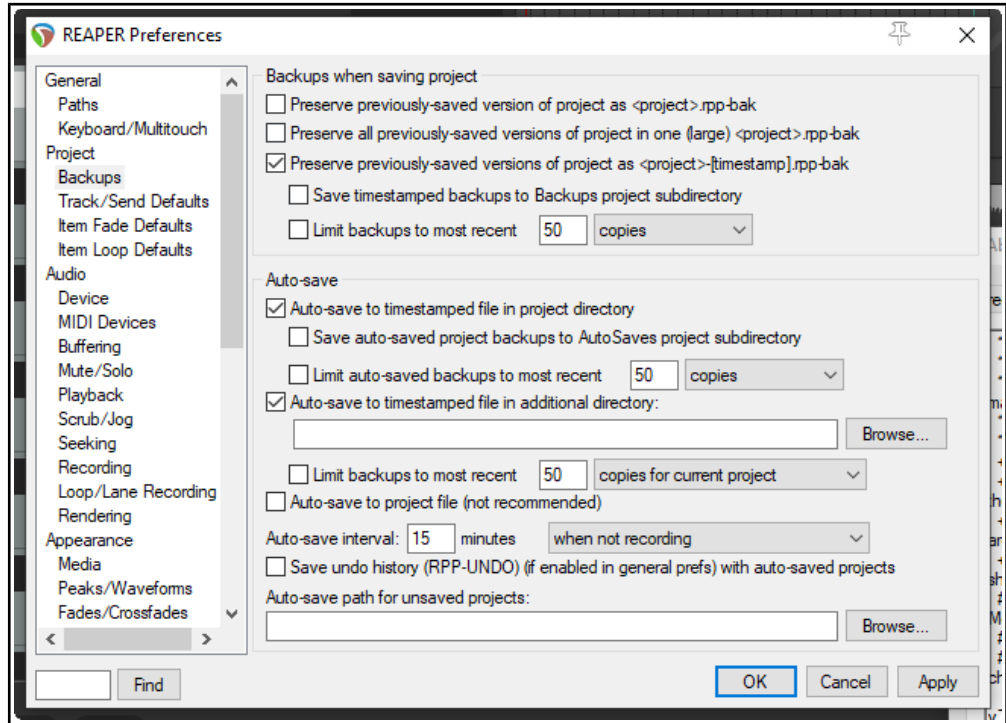

Backup options are:

- ◆ **Backups when saving project.**
 - ◆ **Preserve previous saved version as rpp-bak file, or**
 - ◆ **Preserve all previously saved versions of project in one large rpp-bak file, or**
 - ◆ **Preserve previously saved versions of project as timestamped rpp-bak file, or**
 - ◆ **None of these.**
- ◆ **Save timestamped backups to Backups project subdirectory.** Helps to keep backup files organised and accessible.
- ◆ **Limit [number of] backups to most recent *n* copies or unique days.** Sets a limit to prevent obsolete or redundant backups creating too much file clutter on your disk(s).

Auto-save options are:

- ◆ **Auto-save to timestamped file in project directory.**
- ◆ **Save auto-saved project backups to Auto-Saves project subdirectory.**
- ◆ **Limit auto-saved backups to most recent *nn* copies or unique days.**
- ◆ **Specify directory for auto-saves to timestamped file.**
- ◆ **Limit backups to most recent *nn* copies for current project, or unique days for current project, or copies for all projects, or unique days for all projects.**
- ◆ **Auto-save to project file.**
- ◆ **Set auto save interval to *nn* minutes when not recording, or when stopped, or any time.**
- ◆ **Save undo history (RPP-UNDO) (if enabled in General Prefs) with auto-saved projects.**
- ◆ **Specify auto-save path for unsaved projects.**

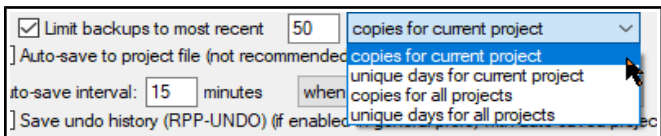

REAPER 7.0: What's New

Other Changes to Preferences

REAPER's preferences have been significantly reorganised, including the introduction of several new pages, some of which replace former sections and a considerable number of new items. Here is a summary of the main changes.

See the full REAPER User Guide (Chapter 22) for further details and explanations.

Sections removed

- Project, Media Item Defaults
- Appearance, Media Item Positioning

New sections:

Project, Item Fade Defaults

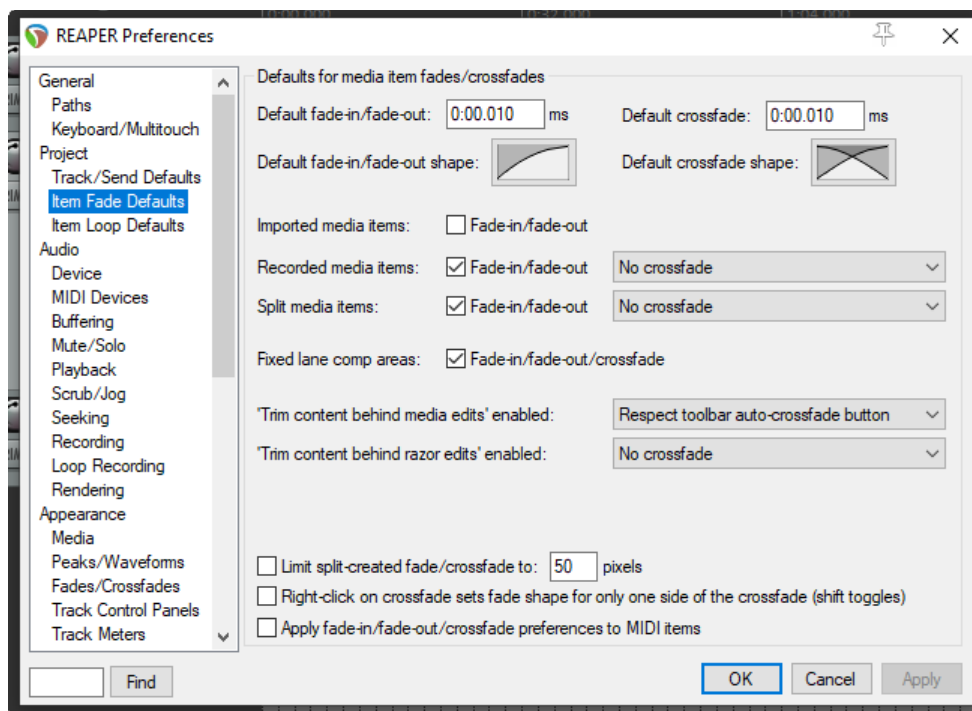

Project, Item Loop Defaults

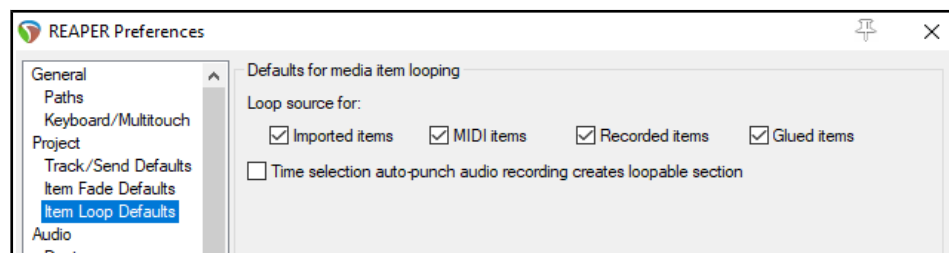

REAPER 7.0: What's New

Audio, Scrub/Jog

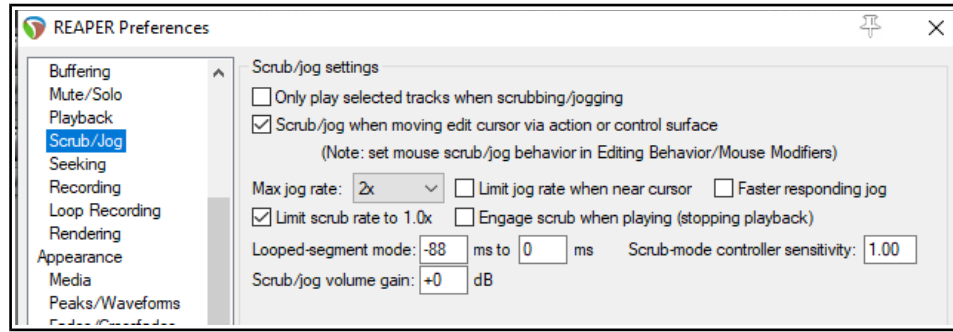

Appearance, Loop/Lane recording

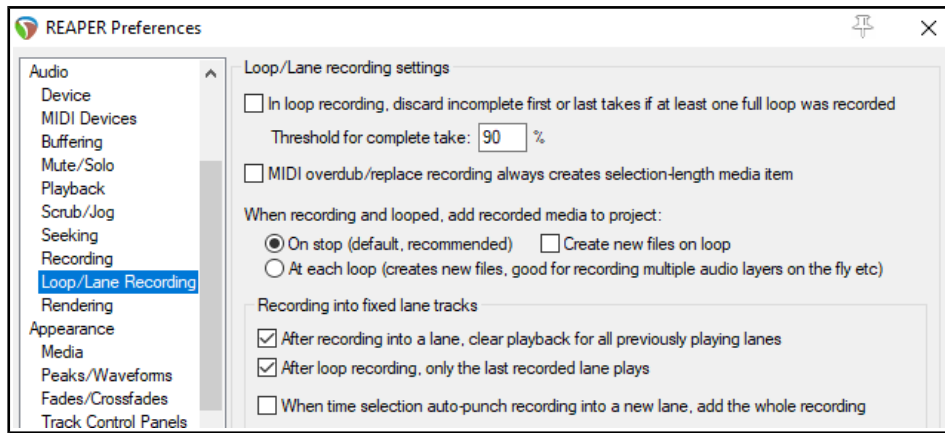

Project, Track/Send Defaults

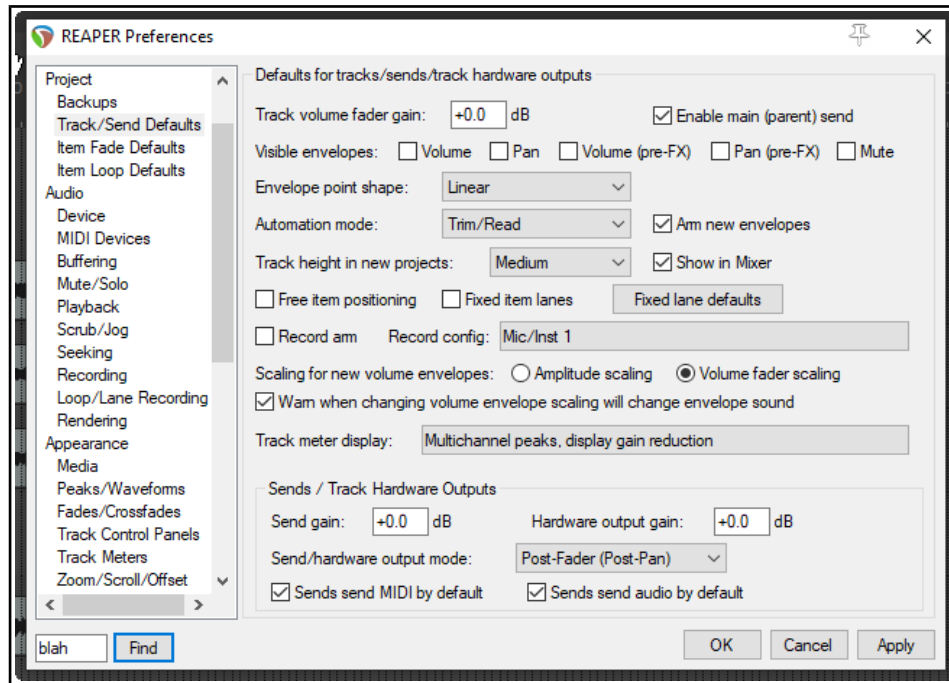

REAPER 7.0: What's New

Appearance, Envelope colors

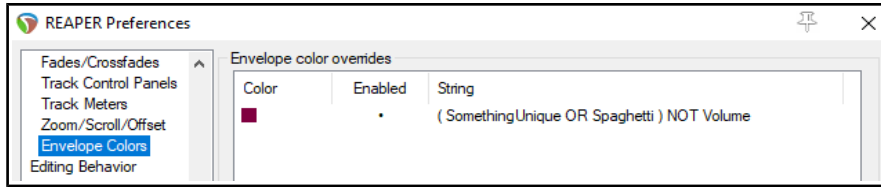

Appearance, Track Control Panel

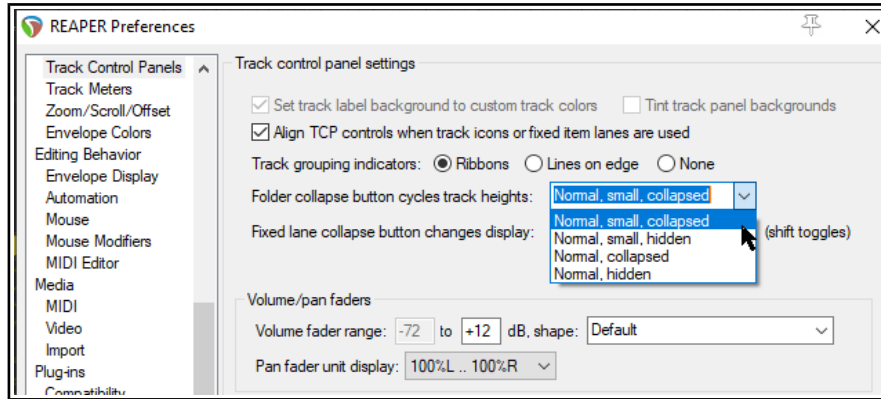

Appearance, Track Meters

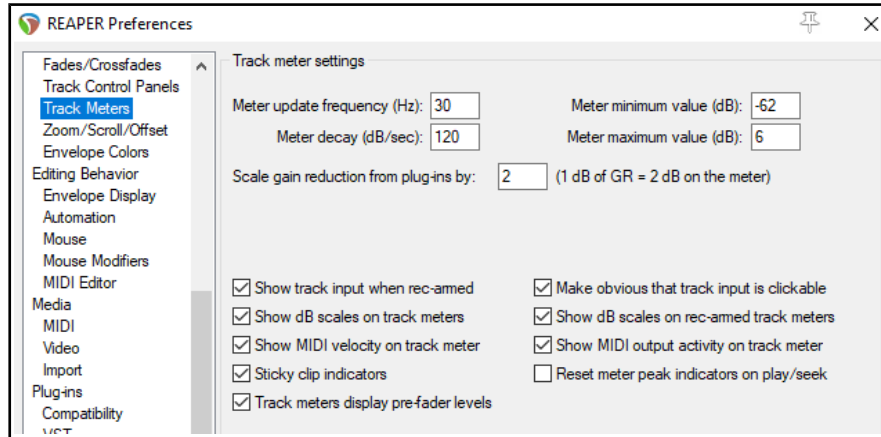

Appearance, Zoom/Scroll/Offset

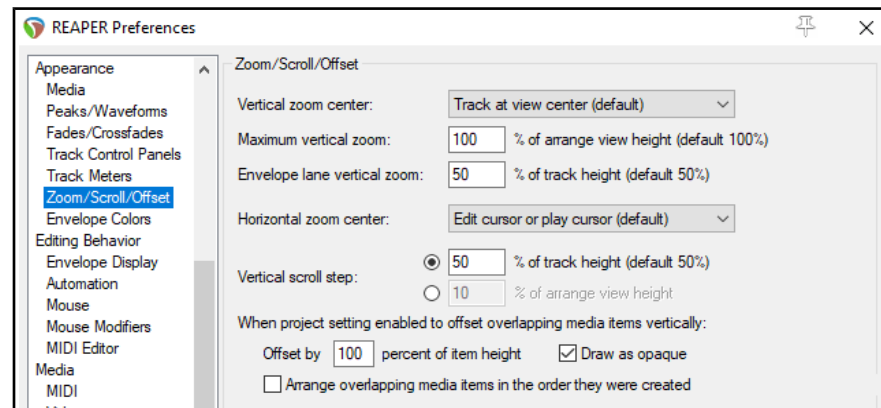

REAPER 7.0: What's New

Plug-ins, ARA

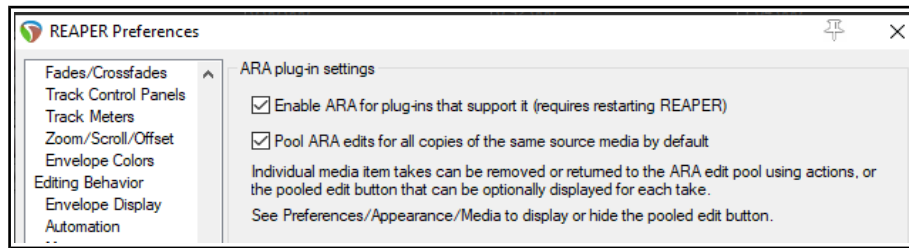

Summary of main changes/additions to preferences

The following preference options have been added:

- Separate fade options for imported, recorded and split media items (Project, Item fade defaults)
- Set default height for fixed items lanes (Project, Track/Send defaults)
- Set meter display preference for new tracks (Project, Track/Send defaults)
- Option to show gain reduction meters in tracks (Project, Track/Send defaults)
- Separate loop source options for imported, MIDI, recorded, and glued items (Project, Item loop defaults)
- Temporarily bypass oversampling/auto-bypass FX (Audio)
- Reduce CPU usage when processing silent passages (Audio, Playback)
- Scrub/jog volume gain (Audio, Scrub/Jog)
- Seek if media items clicked when moving edit cursor (Audio, Seeking)
- Disable auto-bypass when offline/stem rendering, or applying FX (Audio, Rendering)
- Not to animate toolbar buttons (Appearance)
- Option to hide child tracks when collapsing folders (Appearance, Track Control Panel)
- Scale gain reduction on track meters (Appearance, Track Meters)
- Envelope lane height to be set as percentage of track height (Appearance, Zoom/Scroll/Offset)
- Set vertical zoom limits (Appearance, Zoom/Scroll/Offset)
- Draw a selection indicator on selected items (Appearance, Media)
- Hide child tracks during folder collapse toggle cycle (Appearance, Track Control Panels)
- Options to customise envelope colors (Appearance, Envelope Colors)
- ARA options added, including option to pool ARA edits (Plug-ins, ARA)